

RR4T USA - RS4T USA
400 - 450 - 525



Four Stroke



RR4T USA - RS4T USA 400-450-525

The information described in this enclosure are updates to the Europe version

Label location RR4T USA	2
Label location RS4T USA	3
Controls RR4T USA	4
Controls RS4T USA	5
Digital speedometer RR4T USA - RS4T USA	6
Wiring diagram RR4T USA	10
Wiring diagram RS4T USA	12
Fuel cock	14
Choke	15
Adjusting the slow running	15
Canister filter	16

LABEL LOCATION **RR4T USA**

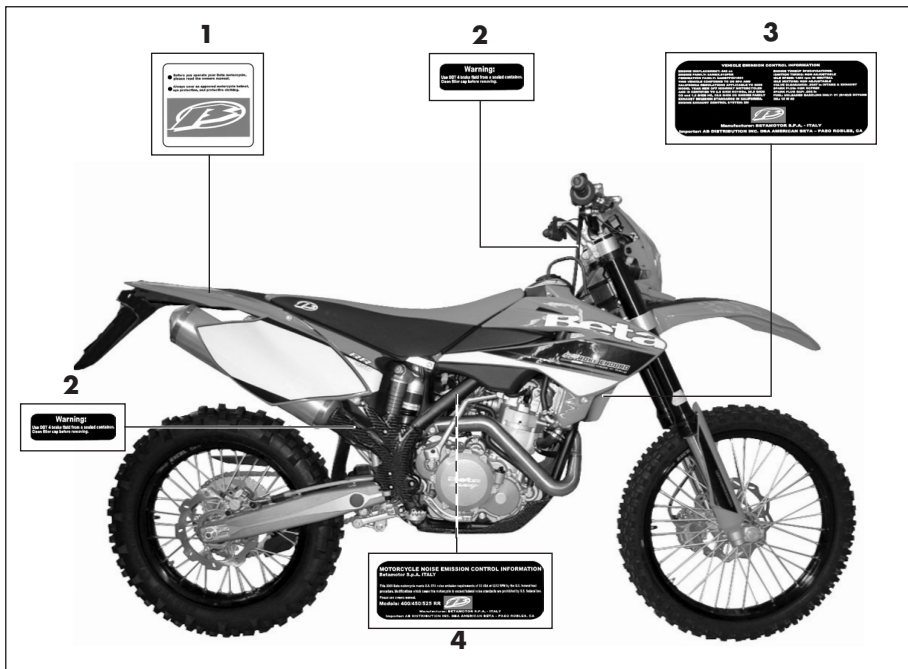

Label RR4T:

- 1** – Warnings plate
- 2** – Brake oil plate
- 3** – Technical plate
- 4** – Eco-plate

LABEL LOCATION **RS4T USA**

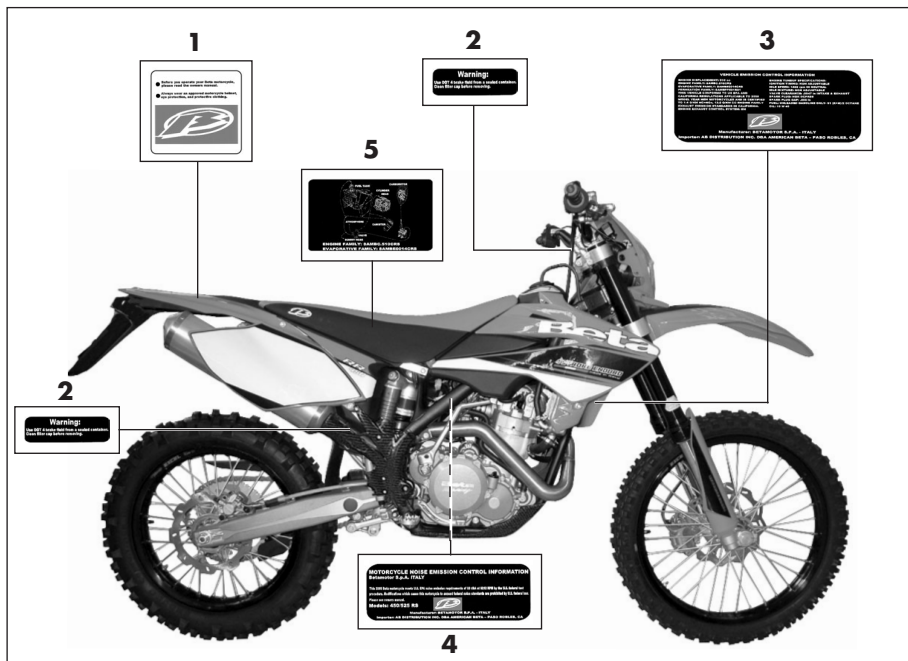

label RS4T:

- 1** – Warnings plate
- 2** – Brake oil plate
- 3** – Technical plate
- 4** – Eco-plate
- 5** – Vapour recovery diagram (under saddle)

CONTROLS **RR4T USA**

RH SWITCH

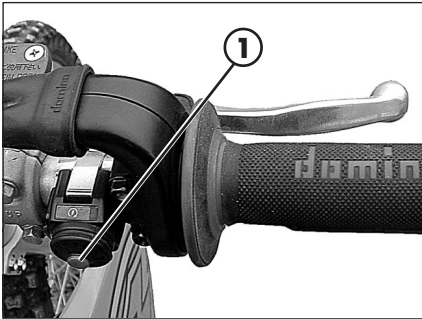

Starte button **1** is located on the right-hand side of the handlebars and operate the electri engine starter. Push the button until the engine sterts.

Do not press the button **1** while the engine is running.

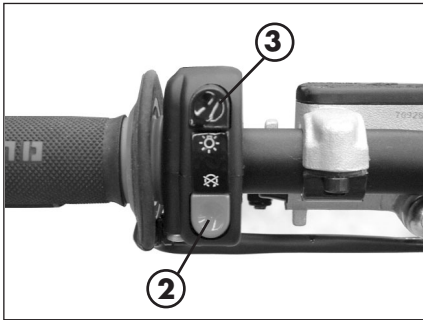

LH SWITCH

Switch **2** is used to stop the engine. Press the button until the engine stops.

While button 3 turns on the lights

CONTROLS **RS4T USA**

RH SWITCH

Starte button **1** is located on the right-hand side of the handlebars and operate the electri engine starter. Push the button until the engine starts.

Do not press the button **1** while the engine is running.

While button 2 turns off the engine.

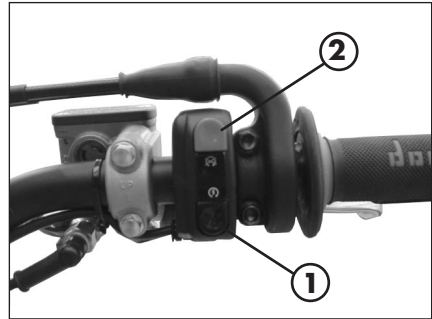

Caution:

Before turning it on, make sure the switch 2 is on ON.

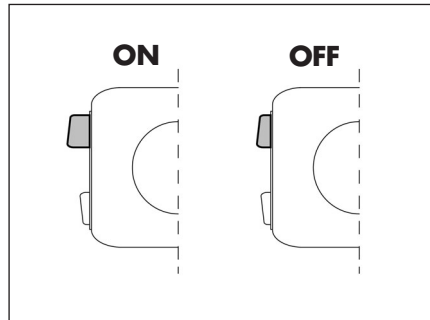

LH SWITCH

Dip switch **3** has three positions:

A = lights off

B = low beam on

C = high beam on

Button **4** operates the horn.

Switch **5** is used to stop the engine. Press the button until the engine stops.

Shifting lever **6** left or right activates the left or right indicators (if installed). When released, the returns to the central position. Press it to turn the indicators off.

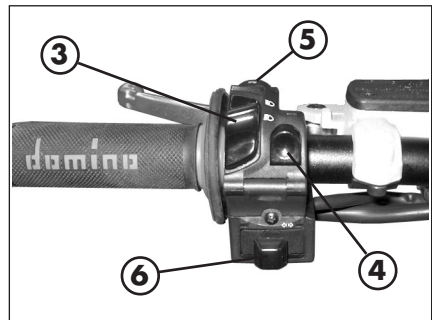

DIGITAL SPEEDOMETER **RR4T USA**

Note:

Information for setting the **RR4T USA** digital dashboard is in the Main Manual and vehicles for the US market are factory set in Mph.

DIGITAL SPEEDOMETER **RS4T USA**

CYCLING THROUGH THE FUNCTIONS

It is always possible to cycle through the different functions while the vehicle is stationary or in motion. Pressing button C or D displays the following functions in succession:

TIME - LAP - TOD - TD - COUNTDOWN

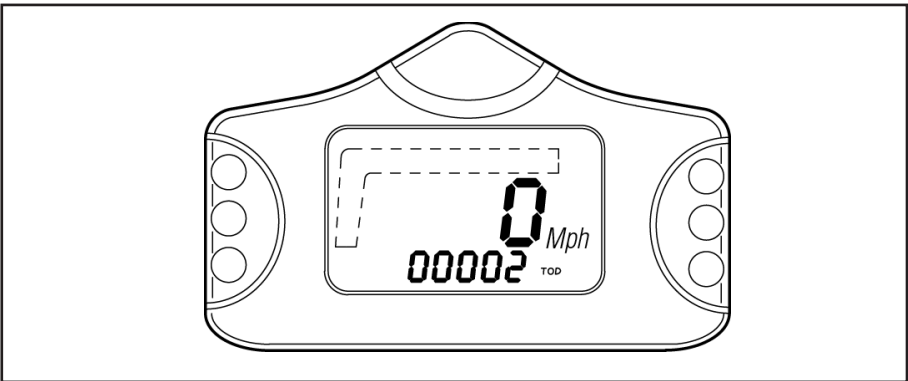

BUTTON FUNCTIONS

The functions of the buttons change with the function currently displayed:

- 1 - TIME $T \geq 3''$ and $Vel=0$ activates time setting mode - $T < 3''$ or $Vel > 0$ cycles through functions
- 2 - LAP $T \geq 3''$ resets LAP and TD - $T < 3''$ cycles through functions
- 3 - TOD $T \geq 3''$ and $Vel=0$ enables setting of circumference, unit and number of pulses for each wheel turn - $T < 3''$ or $Vel > 0$ cycles through functions
- 4 - TD $T \geq 3''$ resets LAP and TD - $T < 3''$ cycles through functions
- 5 - COUNTDOWN $T \geq 3''$ and $Vel=0$ enables setting of countdown - $T < 3''$ or $Vel > 0$ cycles through functions.

T = Time during which button is pressed down

Vel = Speed of vehicle

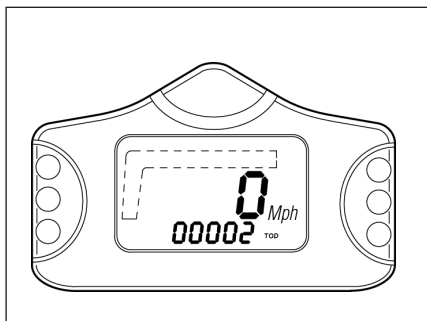

CURRENT SPEED FUNCTION

This information is constantly displayed together with an indication provided by a graphic bar. The default unit is Mph. To change the unit, press the button to access the Setup menu and select km/h. When Mph is selected, no indication is provided as to which unit is currently displayed.

1 - TIME FUNCTION (TIME)

$T \geq 3''$ and $Vel=0$ activates time setting mode

$T < 3''$ or $Vel > 0$ cycles through functions

The time can only be set while the vehicle is stationary.

Press and hold button C or D for more than 3 seconds to enter the time setting mode.

Once the time has been set, press the button for about 3 seconds to go back to the standard operating mode. The Time parameter is displayed in the 0-12 format if Mph has been selected, and in the 0-24 format if Km/h has been chosen. When in the setting menu, if no buttons are pressed for 20 seconds the system will automatically return to the standard operating mode.

Moving off ($Vel > 0$) while the setting mode is activated causes the system to automatically return to the standard operating mode.

2 - AUTOMATIC LAP FUNCTION (LAP)

$T \geq 3''$ resets LAP and TD

$T < 3''$ cycles through functions

This information represents the actual riding time associated with the TD parameter. It is an automatic counter which is activated by the first pulse generated by the speed sensor and stops 3 seconds after receiving the last pulse from the sensor. The counter for this parameter can be reset while in LAP mode by pressing the C or D button for about 3 seconds until 00'00" is displayed. The LAP function can be reset while the vehicle is stationary or in motion and also causes the reset of the TD parameter.

3 - MILEOMETER FUNCTION (TOD)

$T \geq 3''$ and $Vel=0$ enables setting of circumference, unit and number of pulses for each wheel turn

$T < 3''$ or $Vel > 0$ cycles through functions

The information is displayed together with the TOD caption. Depending on the selected unit, the informat is displayed in Mph (default) or Km/h and is permanently stored in non-volatile memory. It is not possible to reset this information during normal operation of the instruments.

4 - AUTOMATIC TRIP FUNCTION (TD)

$T \geq 3''$ resets LAP and TD

$T < 3''$ cycles through functions

This function is always accompanied by the TD caption. The information displayed represents the total distance covered by the vehicle in kilometres or miles (according to the selected unit). It is an automatic counter which is activated by the first pulse generated by the speed sensor.

The counter for this parameter can be reset while in TD mode by pressing the button for about 3 seconds until 000.0 is displayed. The TD function can be reset while the vehicle is stationary or in motion and also causes the reset of the LAP parameter.

5 - COUNTDOWN TRIP FUNCTION (Countdown)

$T \geq 3''$ and $Vel=0$ enables setting of countdown

$T < 3''$ or $Vel > 0$ cycles through functions

This function is always accompanied by a flashing TD caption. The counter is always active and is automatically decreased by 0.1 kilometres or miles according to the selected unit. The value for this parameter can be changed in TD decrease mode by pressing the button for about 3 seconds while the vehicle is stationary.

The different figures that make up the counter can be altered starting from the most significant figure and shifting in successive steps to the least significant figure.

Pressing the button for a short time decreases the value by one step; pressing it for a longer time allows a different parameter to be selected. After setting the least significant figure, press the button for about three seconds to go back to the standard operating mode. If the parameter reaches 000.0, the system automatically sets it to 999.9.

While in the setting menu, if no buttons are pressed for 20 seconds the system will automatically return to the standard operating mode.

Moving off ($Vel > 0$) while the setting mode is activated causes the system to automatically return to the standard operating mode

SLEEP MODE

One minute after the last pulse from the speed sensor has been received, or after the button was last depressed, the microcontroller switches to a power-saving status named Sleep Mode. In order to save power, all standard instrument activity is suspended, the display and the backlighting are turned off (if the vehicle has no battery the backlighting is automatically turned off as soon as the engine is switched off) and only the clock remains in operation. The system can go into Sleep Mode regardless of the selected function.

WAKE UP (from Sleep Mode)

The system wakes up from Sleep Mode whenever:

- The instrument receives a signal from the speed sensor.
- The button is depressed.

As soon as the microcontroller wakes up the following happens:

- The display and the warning lights are checked (all the warning lights come up providing that power is supplied by the vehicle) for about 2 seconds.
- The selected wheel circumference and number of wheel pulses are displayed for about 2 seconds.
- The last function in use when the system went into Sleep Mode is activated. If the waking up takes place through the electronic transmission (i.e. without pressing the button), the instruments immediately switch to the standard operating mode without checking the display and the warning lights and without showing the selected wheel circumference and number of wheel pulses.

CHANGING THE WHEEL CIRCUMFERENCE AND THE UNIT

This operation is to be performed by an authorized BETAMOTOR workshop.

WIRING DIAGRAM **RR4T USA**

- 1) WHEEL SENSOR
- 2) STARTING BUTTON
- 3) PUSHBUTTON SCROLL
- 4) NO CONNECT TELL TALE LAMP
- 5) NO CONNECT TELL TALE LAMP
- 6) NO CONNECT TELL TALE LAMP
- 7) DISPLAY
- 8) ENGINE STOP BUTTON
- 9) LIGHTS SWICH
- 10) CONTROL GROUP
- 11) REGULATOR
- 12) ELECTROVALVE KIT (OPTIONAL)
- 13) TAIL LAMP (LED)
- 14) FUSE 10 A
- 15) EARTH BRAID
- 16) POSITIVE BATTERY
- 17) STARTER RELAY
- 18) STARTER MOTOR
- 19) NEGATIVE BATTERY
- 20) BATTERY 12V-4AH
- 21) PICK-UP
- 22) ELECTRONIC CONTROL UNIT
- 23) AT COIL
- 24) SPARK PLUG
- 25) EARTH CONNECTION FRAME
- 26) POSITION LAMP 12V-5W
- 27) HEADLAMP 12V-35/35W

Key to colours

Bi = White

Ve = Green

Ma = Brown

Vi = Purple

Bl = Blue

Ne = Black

Gi = Yellow

Rs = Red

Ar = Orange

Az = Sky-blue

Ro = Pink

Gr = Grey

WIRING DIAGRAM **RS4T USA**

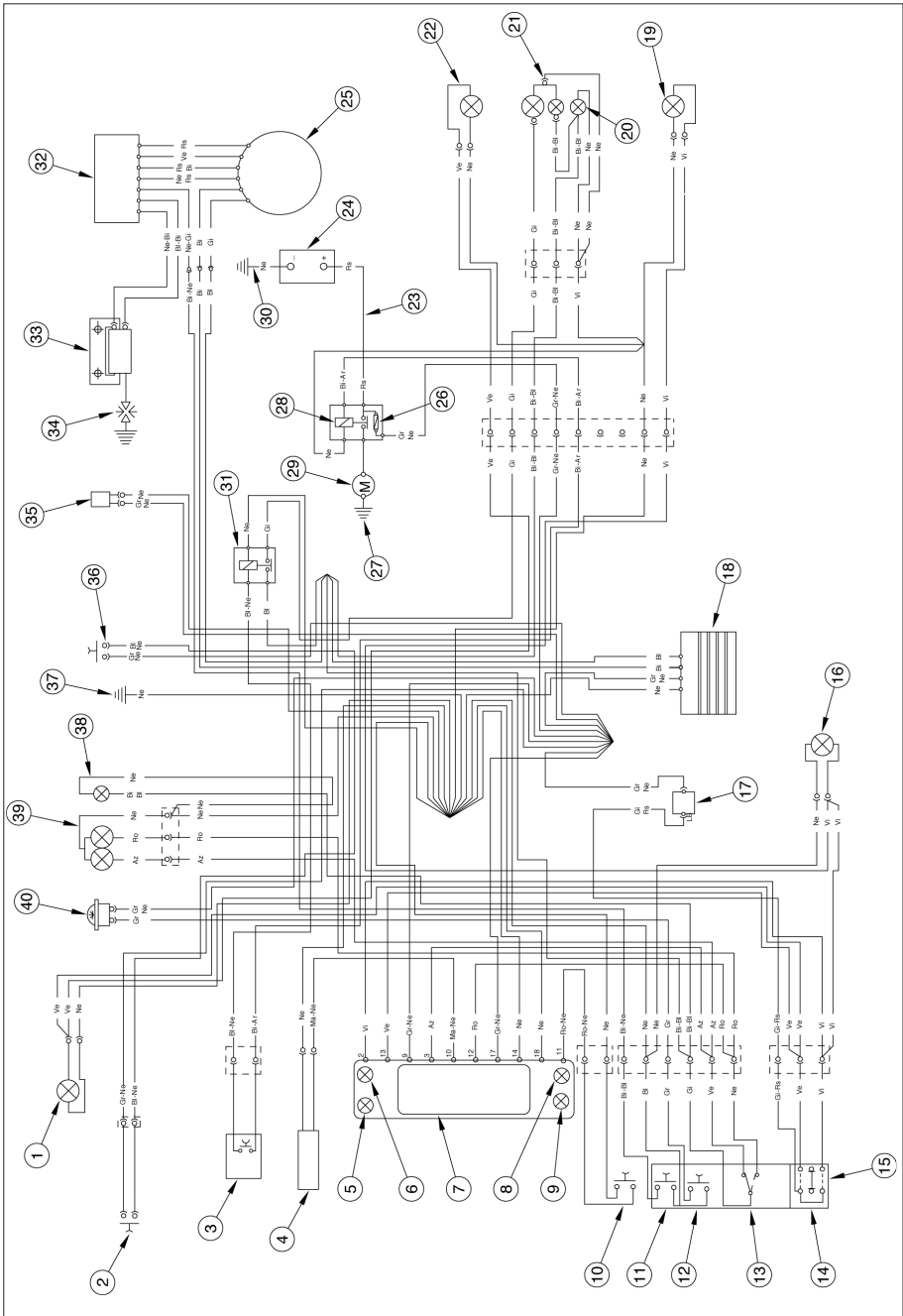

WIRING DIAGRAM **RS4T USA**

- 1) RIGHTHAND FRONT TURN INDICATOR (12V-10W BULB)
- 2) FRONT BRAKE LIGHT BUTTON
- 3) START BUTTON
- 4) WHEEL REVOLUTION SENSOR
- 5) HIGH BEAM WARNING LIGHT
- 6) TURN INDICATOR WARNING LIGHT
- 7) DISPLAY
- 8) LOW BEAM WARNING LIGHT
- 9) NOT CONNECTED
- 10) MODE BUTTON
- 11) ENGINE STOP BUTTON
- 12) HORN BUTTON
- 13) LIGHTS SELECTOR SWITCH
- 14) TURN INDICATOR SWITCH
- 15) LEFT-HAND CONTROL SET
- 16) LEFT-HAND FRONT TURN INDICATOR (12V-10W BULB)
- 17) FLASHER UNIT
- 18) 12V REGULATOR
- 19) LEFT-HAND REAR TURN INDICATOR (12V-10W BULB)
- 20) NUMBER-PLATE LIGHT (12V-5W BULB)
- 21) REAR LIGHT (12V-5/21W BULB)
- 22) RIGHTHAND REAR TURN INDICATOR (12V-10W BULB)
- 23) BATTERY POSITIVE TERMINAL
- 24) BATTERY 12V-4Ah
- 25) GENERATOR
- 26) 10A FUSE
- 27) EARTH BRAID
- 28) STARTER RELAY
- 29) STARTER MOTOR
- 30) BATTERY NEGATIVE TERMINAL
- 31) REAR STOP LAMP RELAY
- 32) ELECTRONIC CONTROL UNIT
- 33) HV COIL
- 34) SPARK PLUG
- 35) CONDENSER
- 36) REAR BRAKE LIGHT BUTTON
- 37) FRAME EARTH
- 38) PARKING LIGHT BULB 12V-3W
- 39) HEADLIGHT WITH 12V-25/25W
- 40) 12V HORN

Key to colours

Bi = White
Ve = Green
Ma = Brown
Vi = Purple

Bl = Blue
Ne = Black
Gi = Yellow
Rs = Red

Ar = Orange
Az = Sky-blue
Ro = Pink
Gr = Grey

FUEL COCK

OFF Fuel cock **1** is closed.

ON Before using the vehicle, turn the knob to ON. This allows the fuel to flow to the carburettor. When the fuel cock is in the ON position the fuel tank empties until only the reserve fuel is left.

RES The reserve fuel is used only if the knob is in the RES position. Do not forget to bring the knob back to the ON position after refuelling.

Reserve fuel 1 litre

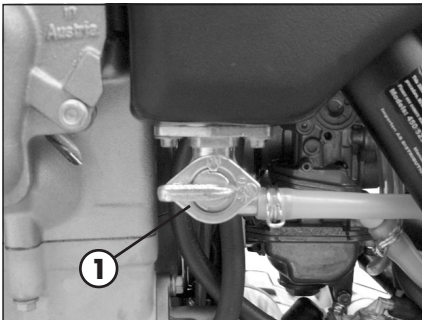
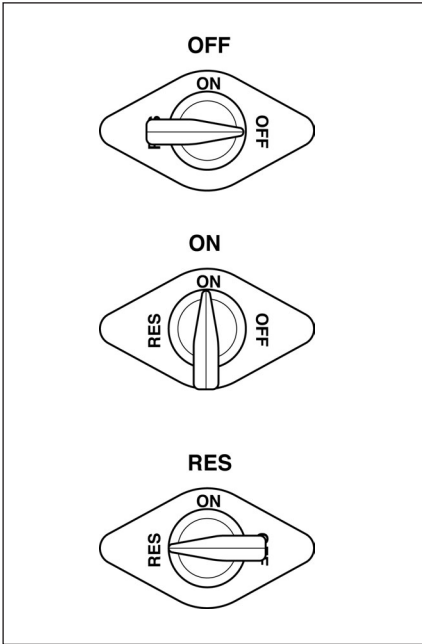

CHOKE

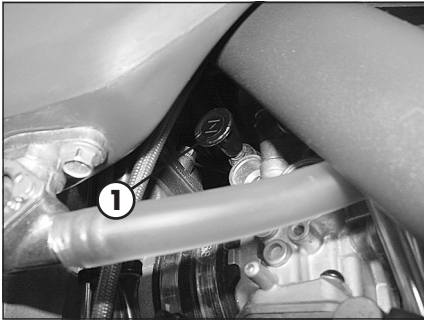

When choke **1** is pulled out completely, a hole is opened in the carburettor through which the engine can suck in extra fuel. This makes it possible to obtain a rich fuel-air mixture suitable for cold starting. To deactivate the choke, push it in to its starting position.

IDLING SETTING

The knob **2** on the carburettor can be used to set the idle speed. Turn the knob clockwise **A** to increase, turn the knob anticlockwise **B** to decrease.

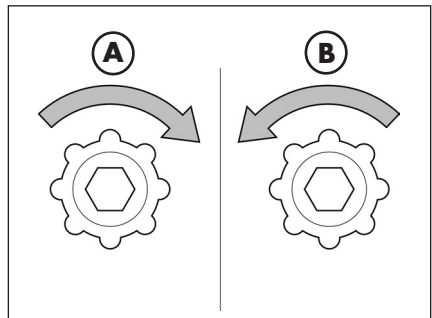
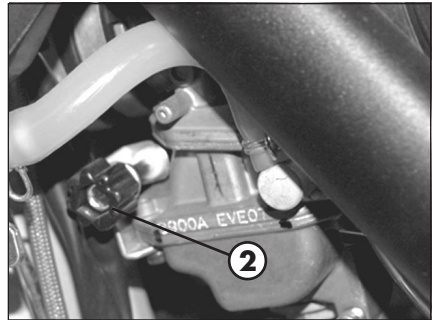

Betamotor S.p.A has always been sensitive to environmental protection, and all vehicles comply with the applicable regulations on harmful gas emissions and sound pollution.

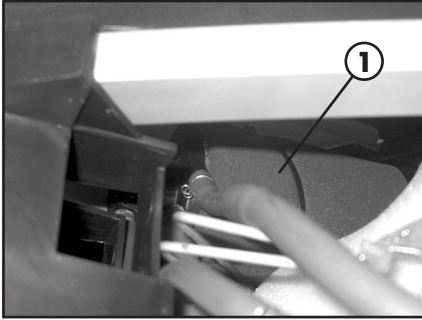

CANISTER RS4T USA FILTER SYSTEM

The extra system with a Canister **1** emission filter and vacuum valve **2** prevent the release of vapours into the atmosphere.

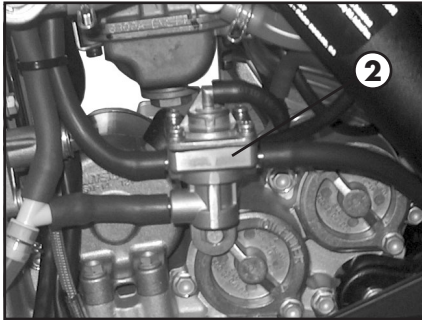

Cod. 21.73289.000